

Bailey & Mackey Ltd



Available Switch Alternatives

	Cooling Coil	Manual Reset (R & RF)	Overload Protection (Q)	Oxygen Cleaned	Gold Contacts (G)	Low Leak Assembly	Adjustable Hysteresis (V)	Plug & Socket (P)	Throttled Transmitter	High Electrical Load (X)
1391										
1491										
1591										
1392										
1492										
2391										
2491										
2591										
2392										
2492										

- = Available
- = Standard
- = Unavailable

Bailey & Mackey Ltd



To make series 1000 pressure switches more suitable for many applications there are several standard options available

Option D – Cleaned for Oxygen Use

Pressure switches for use on oxygen have to be free from all traces of oil or grease. Diaphragm pressure switches have the diaphragm, pressure chamber and seal specially cleaned and handled during assembly and are marked with the 'Use no oil' symbol.

Option G – Gold Plated Micro-Switches

Micro-Switches with gold plated contacts are used in low power circuits where the contact resistance of standard silver contacts is too high. For electrical loads 6V at 0.1A dc.

Option H – Low leak assembly

A modified design of pressure switch is available for use on extinguishers, switchgear, transformers or other sealed pressure systems. Special machining and assembly gives freedom from leaks greater than 10^{-5} l/sec when tested on helium at 1 bar.

Option P – With Plug & Socket

Fitted with 4 – pin plug and socket for SPDT micro-switch version. Fitted with 7 – pin plug and socket for twin SPDT or DPDT micro-switch versions

Option Q – Overload Protection

Pressures above the adjustable range shown in the table should not be applied to the switches. Overload will strain the Diaphragm, either causing distortion that will alter the set point of the pressure switch or reduce the diaphragm life through fatigue failure. Normally, the pressure range should be chosen to cover the highest pressures likely to develop in the system; Series 1000 switches can be constructed to accept higher pressures than the adjustable range by fully supporting the diaphragm above its normal operating deflection. Maximum temperature is 60°C.

Maximum Adjustable Range	Overload Pressure ALT.1	Overload Pressure ALT.2
400 mbar	7 bar	-
1 bar	28 bar	-
2 bar to 42 bar	70 bar	200 bar

Option R & RF – Manual Reset

On some applications, for safety reasons, a manual reset is required e.g. after changing the filter element or for alarm purposes.

R = Manual reset above the set point

RF = Manual reset below the set point

Option V – Adjustable Hysteresis (Reset Differential)

This option enables the hysteresis to be increased and can be varied between approximately 5% and 95% of the adjustable pressure range

Option X

In some applications a higher electrical rating is required, this option is fitted with a micro-switch rated 15 Amps at 250V 50Hz.

Bailey & Mackey Ltd

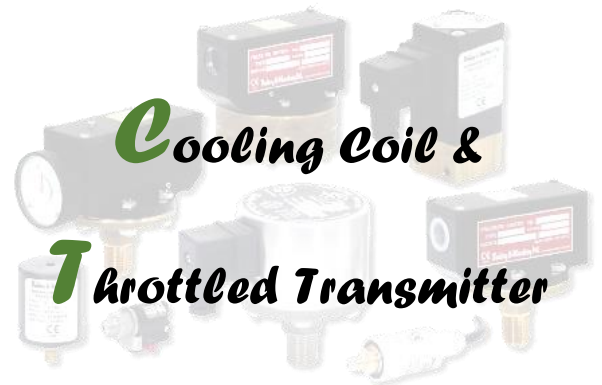

- For temperatures up to 200°C
- For Viscous or Corrosive Fluids

The Pressure switch body is isolated from the heat source via a secondary diaphragm and coiled copper tube allowing the heat to be dissipated. The flange clamping bolts must not be un-tightened as this will break the pressure seal and render the switch in-operative

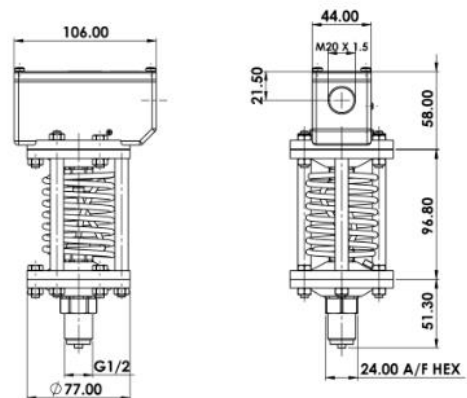

- Stops pressure pulses giving false switching

In many applications where pressure switches are used it is not possible to provide protection against pulsating pressure by means of a snubber involving small orifices. The Bailey & Mackey solution to this problem is integral hydraulic damping, allowing a mean switch point to be achieved irrespective of the severity of pressure pulses.

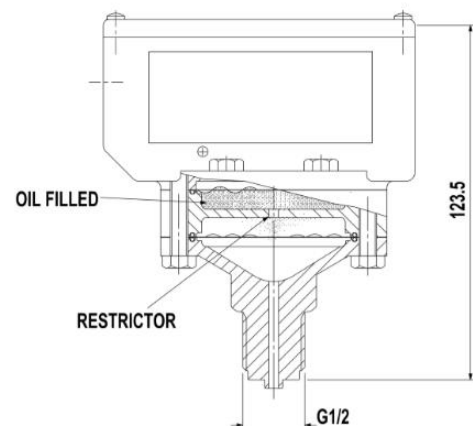

Bailey & Mackey Ltd



Alternative Fittings

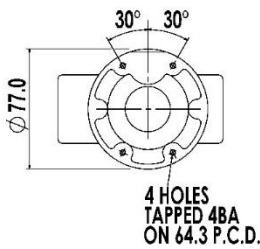
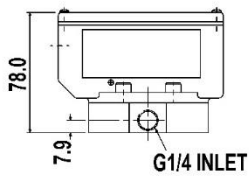

BLOCK BASE

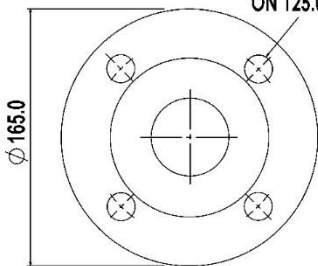
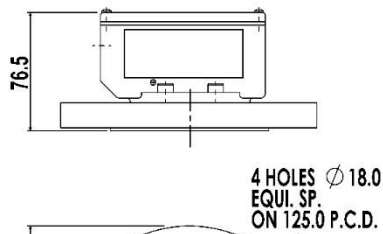

**50mm PIPE FLANGE TO
BS EN 1092-1 PN16**

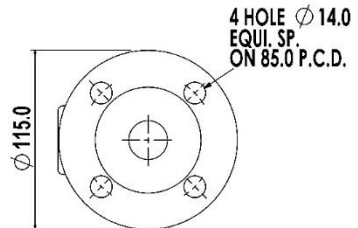
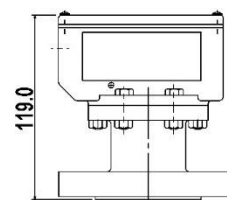

**25mm PIPE FLANGE ADAPTOR
TO BS EN 1092-1 PN16**

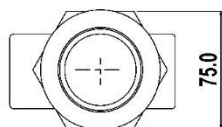
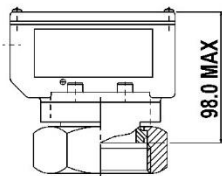

**HYGENIC FITTING
BASE MATERIAL - ST. STEEL**

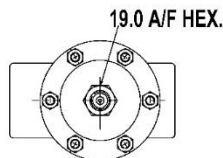
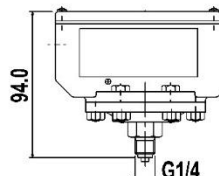

SMALL BASE CONNECTION

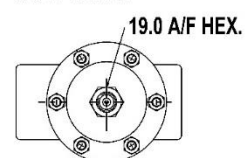
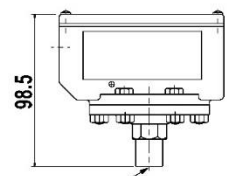

FEMALE CONNECTION